

# **CHANCE<sup>®</sup>**

## **Helical Foundations for Telecom Structures**

- **Site development • Augmentation**
- **Retrofit/upgrades • Guy Anchors**
- **Platform & Shelter Supports**

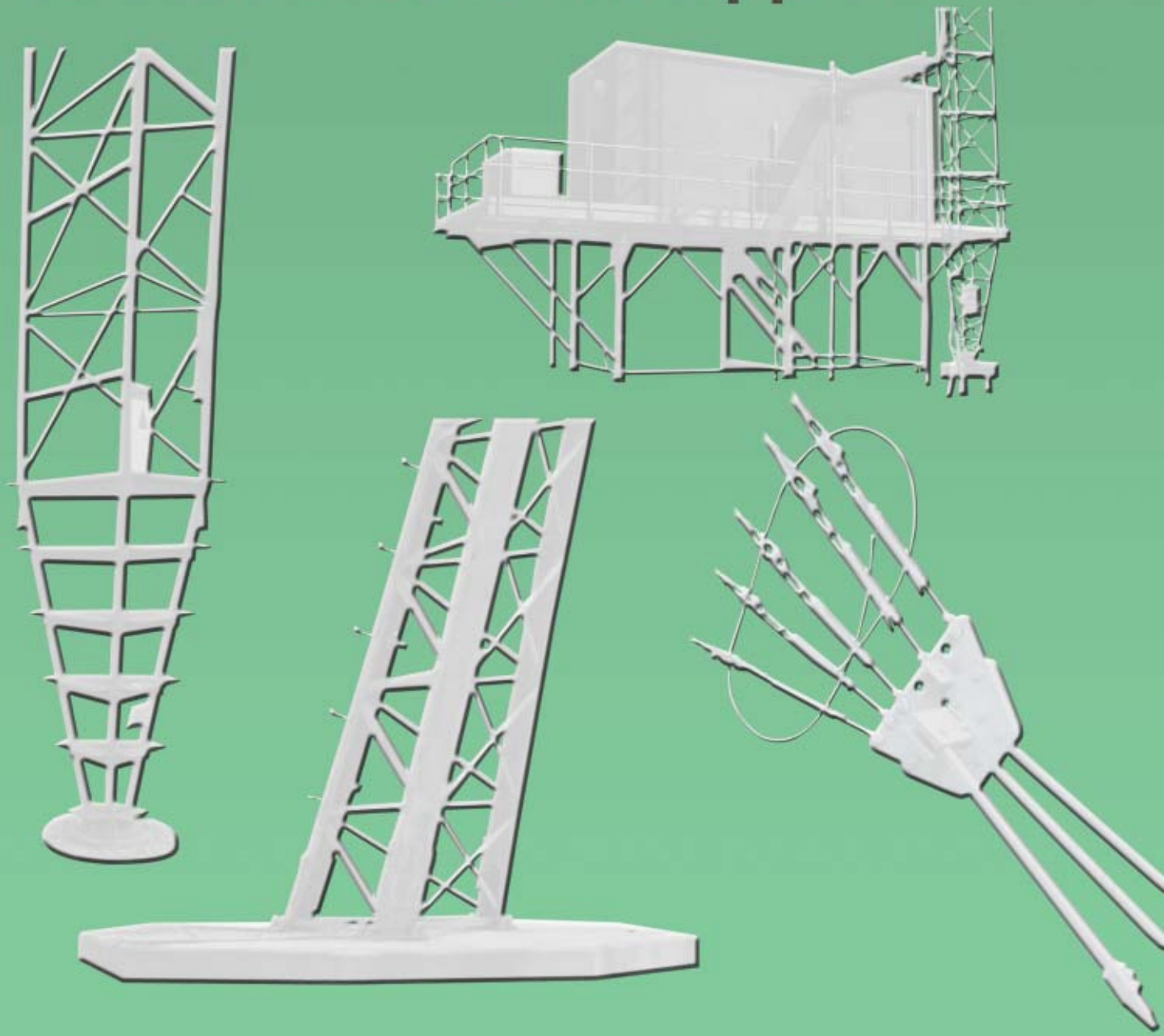

# Engineered foundation technology for fast Telecom Tower build-out!

- **Speed your sites to market**
  - Nothing faster than our all-steel piles and guys
  - No excavation spoils; torque indicates capacity
- **Immediately apply loads**  
No start/stop delays of formed concrete
- **Lower foundation costs**  
Labor-competitive at most sites, simpler, easier



- **Utilize "inaccessible" sites**  
Modular system installs by low-psi machines
- **Solve weak soil situations**  
Helical Pulldown® Micropiles develop ultra-high loads through soft surfaces



## Exclusive services —

- Installed-cost estimates
- Installer training & certification
- **New!**  
**HeliCAP®**  
Engineering Software



# Telecom Industry Applications of CHANCE<sup>®</sup> Helical Foundations and Anchors — for the full range!

## • Telecom Towers

### Guyed Towers

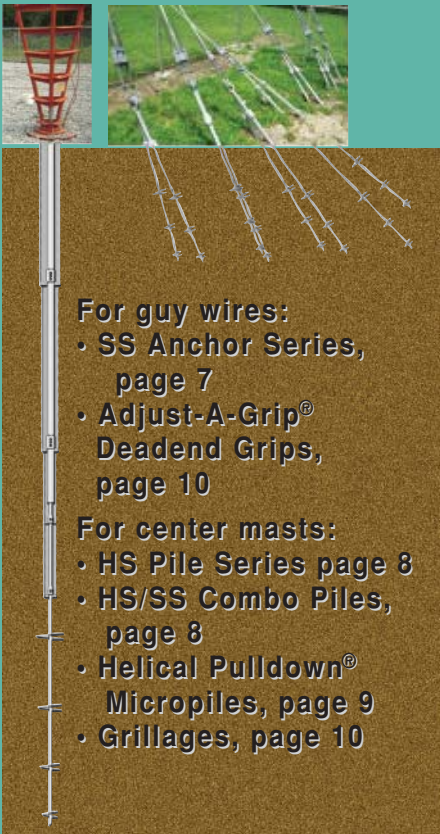

For guy wires:

- SS Anchor Series, page 7
- Adjust-A-Grip<sup>®</sup> Deadend Grips, page 10

For center masts:

- HS Pile Series page 8
- HS/SS Combo Piles, page 8
- Helical Pulldown<sup>®</sup> Micropiles, page 9
- Grillages, page 10

### Self-Supported

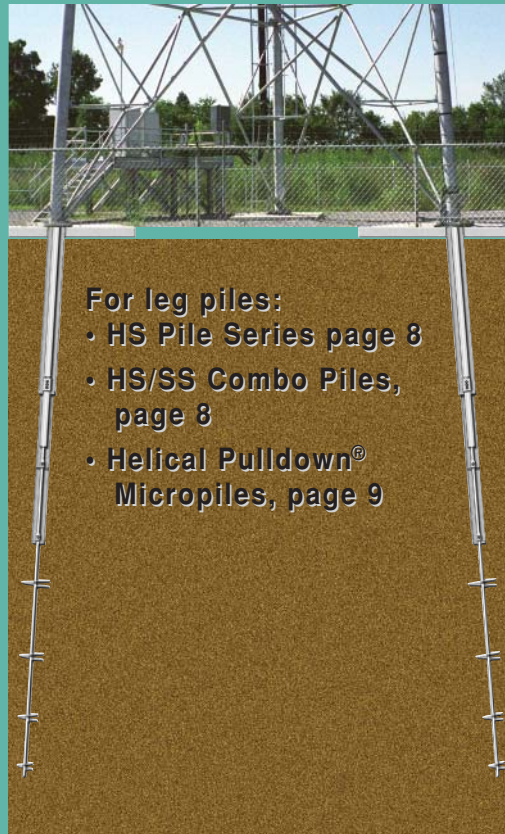

For leg piles:

- HS Pile Series page 8
- HS/SS Combo Piles, page 8
- Helical Pulldown<sup>®</sup> Micropiles, page 9

### Monopoles

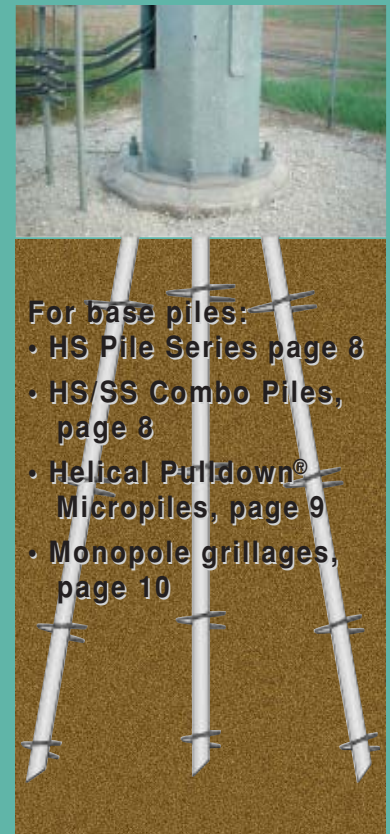

For base piles:

- HS Pile Series page 8
- HS/SS Combo Piles, page 8
- Helical Pulldown<sup>®</sup> Micropiles, page 9
- Monopole grillages, page 10

## • Site Augmentations • Equipment

### Platforms & Shelters

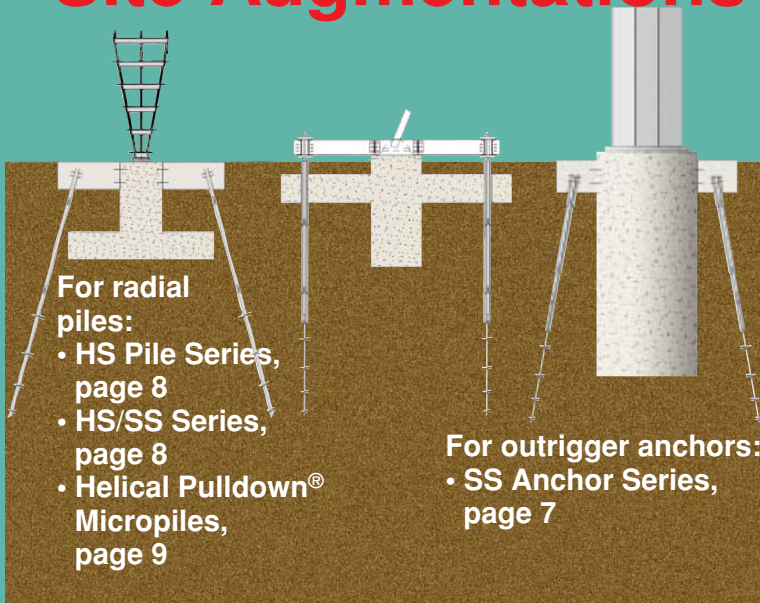

For radial piles:

- HS Pile Series, page 8
- HS/SS Series, page 8
- Helical Pulldown<sup>®</sup> Micropiles, page 9

For outrigger anchors:

- SS Anchor Series, page 7

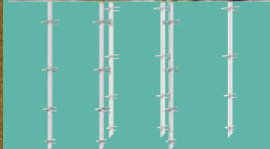

For platform piles:

- HS Series, page 8
- T/C Series, page 8
- Non-Extendable Series, page 8

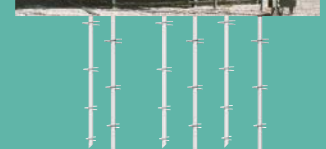

For prefabricated buildings:

- HS Series, page 8
- Helical Pulldown<sup>®</sup> Micropiles, page 9

# THEORY OF FOUNDATION ANCHOR DESIGN

## Soil mechanics

Throughout this discussion we will concern ourselves with the theories of soil mechanics as associated with foundation anchor design. The mechanical strength of the foundations will not be considered in this section as we expect foundations with proper strengths to be selected by the design professional at the time of design. For this discussion, we assume the mechanical properties of the foundations are adequate to fully develop the strength of the soil in which they are installed. Although this discussion deals with the foundation anchor, the design principles are basically the same for either a tension or compression load. The designer simply uses soil strength parameters above or below a helix, depending on the load direction.

## Bearing capacity theory

This theory suggests that the capacity of a foundation anchor is equal to the sum of the capacities of individual helices. The helix capacity is determined by calculating the unit bearing capacity of the soil and applying it to the individual helix areas. Friction along the central shaft is not used in determining ultimate capacity. Friction or adhesion on extension shafts (but not on lead shafts) may be included if the shaft is round and at least 3½" (8.9 cm) in diameter.

A necessary condition for this method to work is that the helices be spaced far enough apart to avoid overlapping of their stress zones. A.B. Chance manufactures foundations with three-helix-diameter spacing, which has historically been sufficient to prevent one helix from significantly influencing the performance of another.

The following reflects the state-of-the-art for determining deep

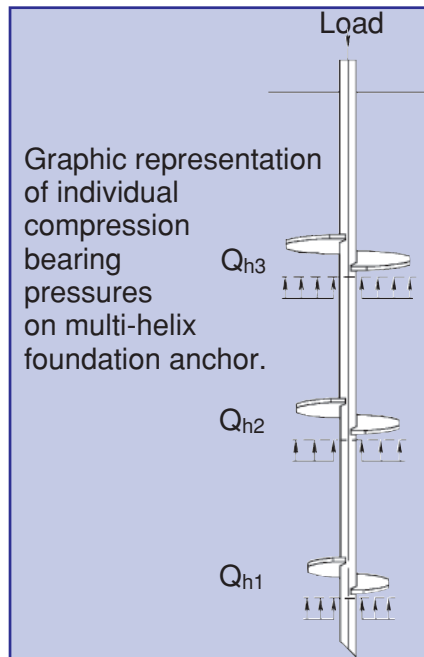

multi-helix foundation capacities as practiced by A.B. Chance.

Ultimate theoretical capacity of a multi-helix foundation equals

### Equation A:

$$Q_t = \sum Q_h$$

Where:

$Q_t$  = total multi-helix anchor capacity

$Q_h$  = individual helix bearing capacity

### Equation B:

$$Q_h = A_h (9c + q N_q) \leq Q_s$$

Where:

$Q_h$  = Individual helix bearing capacity

$A_h$  = projected helix area

$c$  = soil cohesion

$q$  = effective overburden pressure

$N_q$  = bearing capacity factor (from the graph, next page)

$Q_s$  = upper limit determined by helix strength

Projected helix area ( $A_h$ ) is the area projected by the helix on a flat plane perpendicular to the axis of the shaft.

the sum of all individual helix capacities, see Equation A. To determine the theoretical bearing capacity of each individual helix, use Equation B.

For additional information, see Technical Manual, Bulletin 01-9601.

## Cohesive and non-cohesive soils

Shear strength of soils is typically characterized by cohesion ( $c$ ) and angle of internal friction "phi" ( $\phi$ ), given in degrees. The designation given to soil that derives its shear strength from cohesion is "cohesive" and indicates a fine-grain (e.g., clay) soil. The designation given to soil that derives its shear strength from friction is "non-cohesive" or "cohesionless" and indicates a granular (e.g., sand) soil.

The product "9c" from Equation B is the strength due to cohesion in fine grain soils, where 9 is the bearing capacity factor for cohesive soils. The product " $qN_q$ " from Equation B is the strength due to friction in granular, cohesionless soils. The bearing capacity factor for cohesionless soils ( $N_q$ ) may be determined from Figure 1. This factor is dependent upon the angle of internal friction ( $\phi$ ). The curve is based on Meyerhoff bearing capacity factors for deep foundations and has been empirically modified to reflect the performance of foundation anchors. Effective overburden pressure ( $q$ ) is determined by multiplying a given soil's effective unit weight ( $\gamma$ ) times the vertical depth ( $d$ ) of that soil as measured from the surface to the helix.

For multiple soil layers above a given helix, effective overburden pressure may be calculated for each layer and then added together.

When  $c$  and  $\phi$  for a given soil are both known,  $(9c + qN_q)$  can be solved directly. However, soil re-

## Bearing Capacity Factor for Cohesionless Soils

Figure 1

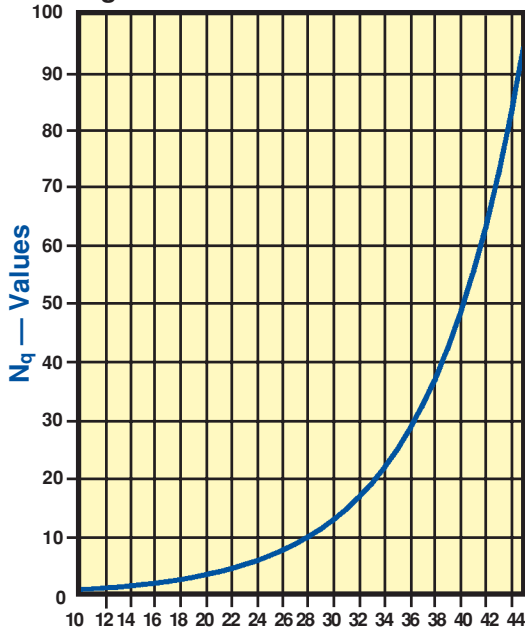

Angle of Internal Friction, degrees

ports often do not contain enough data to determine values for both  $c$  and  $\phi$ . In such cases, Equation B must be simplified to arrive at an answer.

The design professional must decide which soil type (cohesive or cohesionless) is more likely to control ultimate capacity. Once this decision has been made, the appropriate part of the  $(9c + q N_q)$  term may be equated to zero, which will allow solution of the equation. This approach generally provides conservative results. When the soil type or behavior expected cannot be determined, calculate for both behaviors and choose the smaller capacity.

Tension anchor capacities are calculated by using average parameters for the soil above a given helix. Compression capacities may be calculated similarly, however soil strength parameters should be averaged for the soil below a given helix.

We recommend the use of field testing to verify the accuracy of theoretically predicted foundation anchor capacities.

## Theory of the Helical Pulldown® Micropile

The patented Helical Pulldown® Micropile is a composite end-bearing/friction pile designed to both stiffen the pile shaft and develop additional capacity via skin friction along its grouted column. It consists of a steel screw anchor with a grout column above the helical end-bearing plates. The formation of this pile involves the use of circular lead displacement discs and extension displacement discs. The lead discs have angled plates that when rotated during the installation process displace the soil laterally outward away from the pile shaft. There is no soil removed during the installation of a Helical Pulldown® Micropile. The remolded soil at the outside of the displaced annulus would naturally tend to flow back around the lead disc and fill the void created by the disc. However, the use of high-density,

flowable grout acting under hydrostatic pressure prevents the soil from filling this voided annulus. The grout is pulled down as the installation of the anchor continues, thus forming a cast-in-place concrete pile. This concrete column, not only stiffens the pile shaft to allow for the full mobilization of the end bearing capacity of the helices, but also provides additional capacity through the development of skin friction along the formed concrete column.

### Bearing capacity theory

The end bearing capacity of a Helical Pulldown® Micropile is determined by the methods as previously described in this article. Namely, the bearing capacity of each individual helix is calculated using the bearing capacity equation (Equation B). The sum of these individual bearing capacities is equal to the ultimate theoretical bearing capacity of the multi-helix foundation (Equation A).

### Friction capacity theory

Friction piles in clays develop their capacity via adhesion between the pile and the soil. The ultimate friction capacity ( $Q_f$ ) is assumed to be equal to the unit adhesion times the embedded area of the pile. In very soft to soft clays, the unit adhesion is normally assumed equal to the cohesive strength of the clay. In medium and stiff clays, the unit adhesion is typically smaller than the cohesive strength of the clay. The unit adhesion will also vary by the material type of pile, i.e., concrete, steel, timber, etc. Various published tables are available which provide unit adhesion values based on the cohesive strength of the clay and the material type of

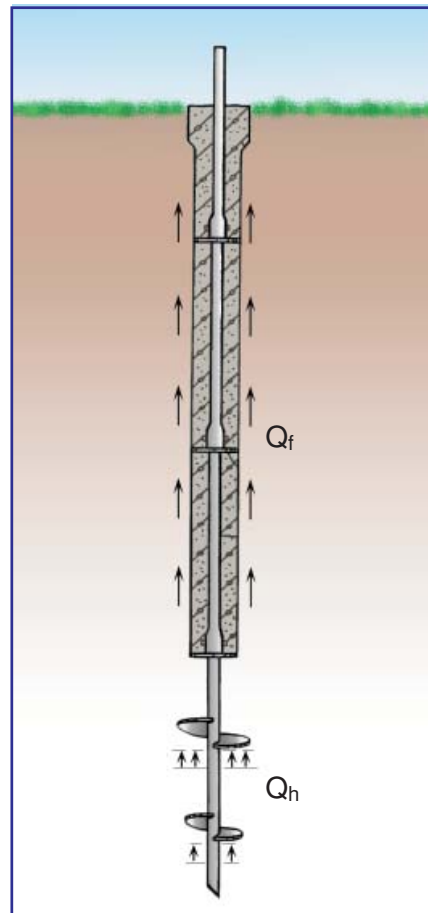

## Basic theory of the Helical Pulldown® Micropile (continued)

the pile. For typical adhesion values, refer to the table shown here.

The friction capacity of piles in sands is a function of the effective lateral pressures along the pile and the effective friction angle between the sand and pile face. The effective friction angle is dependent on the density of the sand and material type of pile. Two methods are presented to determine the ultimate friction capacity ( $Q_f$ ) of a pile. The Alternate Method uses the average friction resistance along the pile. For average friction resistance values along a pile given the angle of internal friction of the soil, refer to the

Recommended Values of Adhesion					
Pile Type	Consistency of Soil	Cohesion, C (PSF)		Adhesion, $C_a$ (PSF)	
Timber or Concrete	Very Soft	0 - 250		0 - 250	
	Soft	250 - 500		250 - 480	
	Medium Stiff	500 - 1000		480 - 750	
	Stiff	1000 - 2000		750 - 950	
	Very Stiff	2000 - 4000		950 - 1300	

Average Overburden Pressure (PSF)	Angle of Internal Friction (degrees)				
	20	25	30	35	40
	S = Average Friction Resistance on Pile Surface Area (PSF)				
500	182	233	289	350	420
1000	364	466	577	700	839
1500	546	699	866	1050	1259
2000	728	933	1155	1400	1678
2500	910	1166	1443	1751	2098
3000	1092	1399	1732	2100	2517
3500	1274	1632	2021	2451	2937
4000	1456	1865	2309	2801	3356

table shown here. These values assume a straight (non-tapered) concrete pile.

The tables above were

derived from Department of Navy Design Manual, "Soil Mechanics, Foundations and Earth Structures."

### Composite pile capacity

It is understood that the end bearing and skin friction along the different segments of a pile may not be mobilized simultaneously. However, the ultimate static resistance ( $Q_t$ ) of a composite pile is normally considered to be the sum of the ultimate end-bearing capacity and the ultimate skin friction on the surface area of the pile.

#### Composite Pile Capacity Equation:

$$Q_t = \sum Q_h + Q_f$$

#### General Equation:

$$Q_f = \sum [\pi D f_s \Delta L_f]$$

Where:  $D$  = diameter, grouted column  
 $f_s$  = sum of friction & adhesion between soil & pile  
 $\Delta L_f$  = incremental pile length over which  $\pi D$  and  $f_s$  are taken as constant, ft.

#### For Cohesive Soils: ( $\alpha$ Method)

$$Q_f = \sum [\pi D C_a \Delta L_f] \quad \text{Where: } C_a = \text{adhesion factor (PSF)}$$

#### For Cohesionless Soils: ( $\alpha$ Method)

$$Q_f = \sum [\pi D (q_a K \tan \delta) \Delta L_f]$$

Where:  $q_a$  = effective vertical stress on element  $\Delta L_f$  (PSF)  
 $K$  = coefficient of lateral earth pressure ranging from  $K_0$  to about 1.75 depending on volume displacement, initial soil density, etc. Values close to  $K_0$  are generally recommended because of long-term soil creep effects. As a result, use  $K_0 = 1$ .

$\delta$  = effective friction angle between soil and pile material  
 (Alternate Method)

$$Q_f = \sum [\pi D (S) \Delta L_f] \quad \text{Where: } S = \text{average friction resistance on pile surface area (PSF)}$$

## INSTALLATION TORQUE VS. ANCHOR CAPACITY

### Holding strength related to installing torque

The idea that the amount of torsional force required to install a foundation anchor relates to the ultimate capacity of the foundation in tension or compression has long been promoted by A.B. Chance. Precise definition of the relationship for all possible variables remains to be achieved. However, simple empirical relationships have been used for a number of years.

Recommended reading on the

subject is in the paper "Uplift Capacity of Helical Anchors in Soil" by R.M. Hoyt and S.P. Clemence (Bulletin 2-9001). It gives the formula for the torque/anchor capacity as:

$$Q_u = K_t \times T$$

where

$Q_u$  = ultimate uplift capacity [lb. (kN)]

$K_t$  = empirical torque factor [ft.<sup>-1</sup> (m<sup>-1</sup>)]

$T$  = average installation torque [ft.-lb. (kN-m)]

The value of  $K_t$  may range

from 3 to 20 ft.<sup>-1</sup> (10 to 66 m<sup>-1</sup>), depending on soil conditions and anchor design (principally the shaft size). For Type SS foundation anchors, it typically ranges from 10 to 12 (33 to 39) with 10 (33) being the recommended default value. For Type HS foundation anchors, the recommended default value is 7 (23). The same values of  $K_t$  are used for both tension and compression loading. Torque monitoring tools available from A.B. Chance provide a good method of production control during installation.

# SS ANCHOR SERIES FOR HEAVY GUYING

## Job-matched design

The SS Anchor Series, derives its name from its Square Shaft design. The solid steel round-cornered-square shafts and precise helical pitches on the bearing plates assure installation ease and loading capacities.

## Variety of configurations to serve many applications

Four sizes (or "families") in the SS Anchor Series match a wide range of soil conditions and load requirements. See the Mechanical Ratings table for basic unit performance ratings.

Within each SS "family," lead and extension section lengths range from 30" to 123". With up to four helices per anchor, helix diameters range from 6" to 14". Multiple helix diameters are available on some SS Anchors for specific performance. Extension sections are available plain or with helices and couple by an integral bolted socket.

To increase product life in aggressive soils, hot-dip galvanizing to ASTM specifications is normally supplied.

## Choice of terminations

Methods for attaching guys to SS Anchors are nearly unlimited. Hardware available from stock are forged adapters for one to three guy wires, threaded rods, ovaleye and chain shackles. Socket and clevis ends are among options for attaching adapters to the anchor shaft.

## Tower guying examples

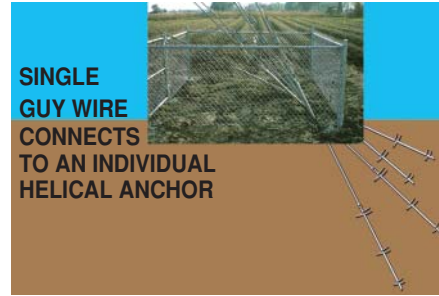

Adjust-A-Grip® Deadend Grips (see page 10) terminate towers guys, above and below.



(Below) SS Anchors terminate multi-level tower guys in concert with fan plates by others and concrete cap cluster method.



**Ideal for Augmentation methods:** • Accommodate additional loads on guyed towers!  
• Outrigger anchors for foundations! • Erect additional towers on a strategic existing site!

Mechanical Ratings	SS 150 1.50" Square Shaft	SS 175 1.75" Square Shaft	SS 200 2.00" Square Shaft	SS 225 2.25" Square Shaft
Maximum Installation Torque	7,000 ft.-lb.	10,000 ft.-lb.	15,000 ft.-lb.	20,000 ft.-lb.
Minimum Ultimate Tension Strength	70,000 lb.	100,000 lb.	150,000 lb.	200,000 lb.

# HS, HS/SS-COMBO and T/C SERIES PILES

## Heavy-load pipe-shaft piles

Instant Foundation® Piles have pipe shafts for resistance to bending moments and lateral loads. Non-extendable series apply to lesser loads of some equipment platforms. Extendable types, based on HS Series, are rated for tower foundations and upgrade retrofits.

The HS/SS Combo and T/C (Tension/Compression) Series employ two graduated shaft diameters. Their combined effect imparts advantages for applications ranging from single units for platform legs to multi-element groups for ultra-high tower loads.

**Ideal for Augmentation!**  
As radial piles to reinforce original foundation for additional loads:

- Cast into concrete collar
- Connect by supplemental outrigger grillage

### Terminations for HS and HS/SS Combo Series

**Platform supports:** Cap plate assembly with clamps to secure beam flanges for shelter and equipment platforms



**Tower foundations:** Steel grillages fit onto a multi-element pile group, page 10

Or they may be cast integrated into a reinforced concrete cap, as at top right



**HS Series Piles**  
3½"-O.D. pipe shaft  
11,000 ft.-lb. maximum torque rating

### Lead Sections

3½, 5, 7, 10 ft. lengths with up to four helices, diameters from 8 to 14 inches, per job requirements

### Extension Sections

3, 5, 7 ft. lengths with three bolts and socket coupler with matching holes at top

**HS/SS Combo Series**  
3½"-O.D. pipe shaft and 1¾" or 2"-square shaft

11,000 ft.-lb. maximum torque rating  
100,000 lb. axial load rating

### HS to SS Transition Section

Top couples to HS Series 3½"-O.D. extensions, above

Forged coupler at bottom available in sizes for SS175 and SS200 Series helical leads and extension shafts, page 7

### Non-Extendable Piles

8,000 to 20,000 ft.-lb. max. torque ratings  
2, 3½, 4, 6, 8, 10"-O.D. pipe

4, 5, 7 ft. nominal lengths with one 10, 12, 14, 16" helix

These INSTANT FOUNDATION® Piles feature top base plates in a range of sizes and bolt circle patterns to serve the attachment and loading needs for supporting certain site equipment platforms



HS/SS Combo Pile group cast in a reinforced concrete cap form each leg support for this 190-ft. tower.



### T/C Series Piles

11,000 ft.-lb. maximum torque rating

**Extension Sections**  
8"-O.D. pipe shaft

3, 5, 7, 10 ft. lengths with 14"-diameter helical couplers top and bottom for bolt-together connections

### Lead Sections

3½"-O.D. pipe shaft

5, 7, 10 ft. lengths with number and sizes of helices per job requirements

### Terminations

Bolted or welded for single element foundations plus grillages for multi-element pile groups, page 10





# Helical Pulldown<sup>®</sup> MICROPILES

## Solution for weak soil sites

The Helical Pulldown<sup>®</sup> Micropile is a patented composite end-bearing/friction pile well suited for resistance to bending moments and lateral loads in poor soil conditions. This type of pile transfers load to high end-bearing-capacity helical plates.

It consists of a steel screw anchor with a 4" to 10" grout column around the shaft above the helical plates. Pile design is specified per application and may consist of SS or HS Pile Series or their combination.

Displacement plates added at extension joints form a cylindrical void in the soil filled by the grout reservoir on grade as the anchor is torqued into the soil. The grout column may be sleeved during installation if required.

Connections to the superstructure may be by steel fabricated brackets or by integration into the rebar gridwork of a concrete pile cap.

## Ideal for Augmentation, too!

Helical Pulldown<sup>®</sup> Micropiles using HS/SS Combo Piles installed in a group and cast in a reinforced concrete cap form each of the leg supports for this 250-ft. tower.



## Ultra-high capacity system, tested to 410 kips per pile

Ideal for high capacity compression and uplift requirements, the Helical Pulldown<sup>®</sup> Micropile system applies to all types of tower foundations and augmentation methods.

Example below shows grout column above the helical plates. Monitoring grout volume and torque during installation contribute to field production control.



# DEADEND GRIPS FOR TOTAL GUYING PACKAGE



## Terminations for top and bottom of guy wires

In strength ratings higher than the intended guy wires, this guy-termination hardware comes in types to serve both the tower and anchor connections. Sizes available for galvanized-steel guy strands up to 1" in diameter include ratings for loads up to 104,500 lb. For aluminum-coated guy strands, sizes range to 1.270" diameter with a 142,900 lb. load rating.

These patented Adjust-A-Grip® Deadend Grips comprise a helical rod subset to grip the guy wire, wedge components that seat in a socket body and a U-bolt with load and jam nuts.

They are quick and easy to install without special tools, eyes, pins, thimbles, clevises or twisted-loop grips. For the tower connection, the non-adjustable type is prescribed. The series for the anchor end provides up to 18" of U-bolt adjustment.

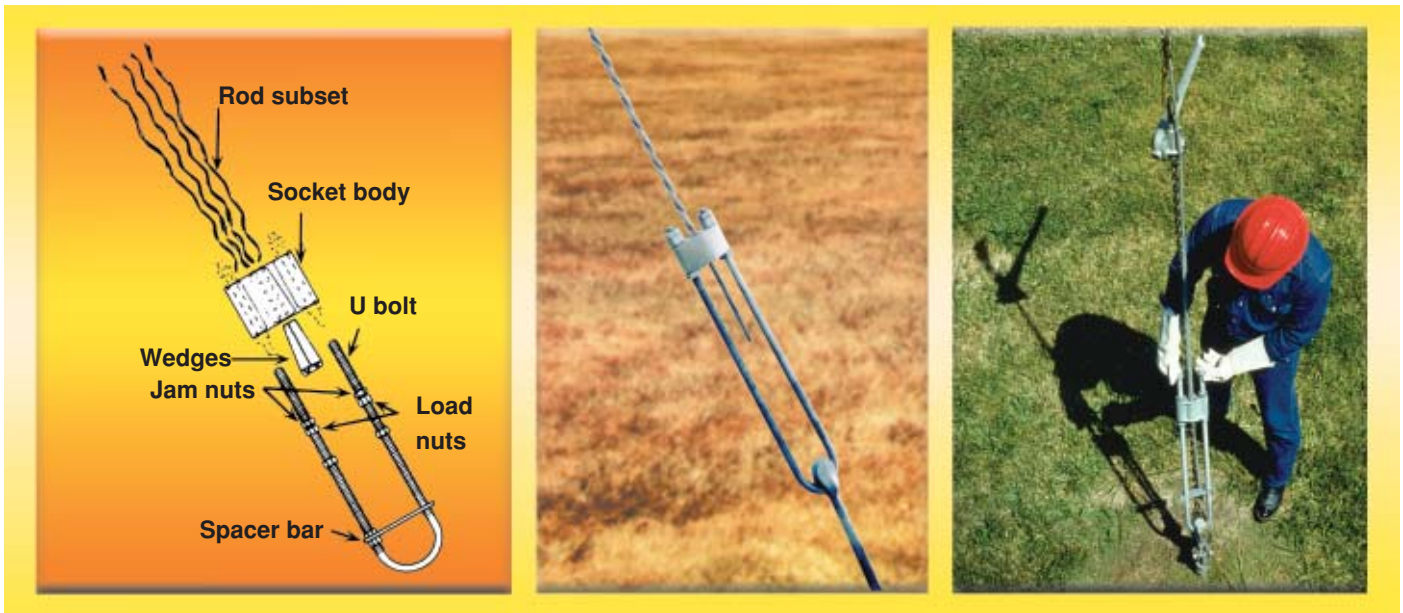

# GRILLAGES FOR MULTI-ELEMENT PILE GROUPS

## Ready-made, custom-built and compatible systems

Available in ratings for 125 and 200 kips, Chance® Tripod Grillage below fits directly on HS and HS/SS-Combo Series Piles (3½"-O.D. pipe shafts) or T/C

Series Piles (8"-O.D. pipe) with ready-made adapters.

Fabricated to the tower site layout, grillage below connects nine HS/SS Series Piles (3½"-O.D. pipe at top with 1¾"-Square Shaft helical leads).

Monopole grillages in pre-manufactured systems (as at right below) provide compatible connections to multi-element pile groups. This pre-engineered design produces foundations with lateral support and resistance to overturning moments.



## Let our experience count for you!

### History

The earliest known use of an anchor foundation was for the support of lighthouses in tidal basins around England. A blind English brickmaker, Alexander Mitchell, is credited with design of a “screw pile” for this purpose in 1833. The use of the “screw pile” was apparently successful, but advancement of the helix-plate foundation did not progress.

In the 1950s, A.B. Chance introduced the Power-Installed Screw Anchor (PISA<sup>®</sup>) for resisting tension loads. The anchor found favorable, widespread acceptance. This anchor consists of a plate or plates, formed into the shape of a helix or one pitch of a screw thread. The plate is attached to a central shaft. The helix plate has its characteristic shape to facilitate installation. Installation is accomplished by applying torque to the anchor and screwing it into the soil. The effort to install the anchor is supplied by a torque motor.

### Research and development

With the development of the tension screw anchor, came the use of the same or similar devices to resist compression loads. Thus, screw pile foundations came into greater use. Various sizes and numbers of helices have been used with shafts of varying sections to provide foundations for different applications. In the past 40 years, projects that have utilized screw pile foundations include electric utility transmission structures, Federal Aviation Administration flight guidance structures, pipeline supports, building foundations, remedial underpinning, streetlights,



walkways in environmentally sensitive areas and many others.

Torque capacities of available installation equipment have increased over the past years. Hydraulic torque motors in the 3,000 to 5,000 ft.-lb. (4.0 to 6.8 kN-m) range have increased to the 12,000 to 15,000 ft.-lb. (16 to 20 kN-m) range. Mechanical diggers now extend the upper range to 50,000 ft.-lb. (68 kN-m) or more. “Hand-held” installers have expanded the available equipment in the lower range of torque, with a capacity up to 2,500 ft.-lb (3.4 kN-m). Though called “hand-held,” these installers are hand-guided while a torque bar or other device is used to resist the torque being applied to the screw pile foundation.

As suggested earlier, the screw pile foundation may be utilized in various forms. The lead section (i.e., the first part to

enter the ground) may be used with one or more helices (generally, four is the maximum) with varying diameters in the range from 6 to 14 inches (15 to 36 cm). Extensions, either plain or with additional helices, may be used to reach deep load-bearing strata. Generally, eight is the maximum number of helices used on a single screw pile foundation. The shaft size may vary from 1½" (3.8 cm) square solid bar material to 10" (25 cm) diameter pipe material. The number and size of helices and the size and length of shaft for a given application are generally selected based on the in-situ soil conditions and the loads that are to be applied.

### Advantages

The screw pile foundation system is known for its ease and speed of installation. Installation generally requires no removal of soil, so there are no spoils to dispose of. Installation causes a displacement of soils for the most part. However, in the case of a foundation with a pipe shaft, some soil will enter the interior of the pipe until it becomes plugged. Installation equipment can be mounted on vehicles when required. The installation of a screw pile foundation is for practical purposes vibration free. These features make the screw pile foundation attractive on sites that are environmentally sensitive. Installations near existing foundations or footings generally cause no problems. However, the screw pile foundation generally cannot be installed into competent rock or concrete. Penetration will cease when materials of this nature are encountered.

# Advantages for all Telecom Tower principals

- Tower owners
- Signal carriers
- Site developers
- Project managers
- Contractors
- Civil & Structural engineers

For turnkey tower anchoring services, turn to Helical Tower Foundation Distributors



- Layout to plan detail specs



- Construct pile caps as required



- Install piles and anchors



## Computer Assisted Foundation and Anchor Design Software

The only computer program of its kind, Chance® HeliCAP® Engineering Software is an easy-to-use interactive program that provides helical anchor solutions for foundation and retaining projects. Its graphics simulate “virtual anchoring” on screen in a PC Windows environment. It performs powerful, sophisticated calculations, based on your project parameters, to derive the proper Chance anchor.

Available on CD, it includes Help screens and Reference materials and gives you prompts to maintain control to analyze problems and specify solutions.

See the FREE demo at [www.abchance.com](http://www.abchance.com) then ask Helical Tower Foundations about getting your copy!

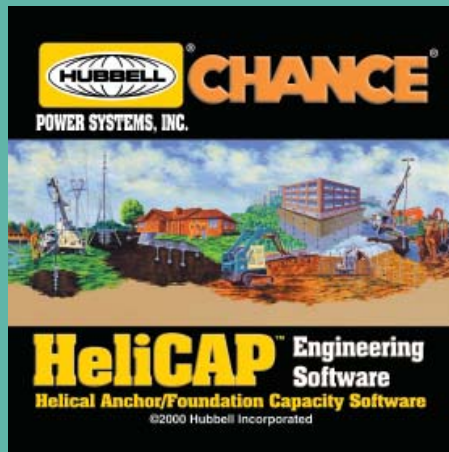

### You make these inputs:

1. Soil type, layer depths, strength parameters;
2. Anchor length, helix configuration, angle of installation, distance to datum;
3. Load – magnitude and direction.

### It gives you this output:

Bearing capacities in tension and compression of an anchor in the given soil conditions.

Distributor to the Telecom Industry:



125 Homas Road • Lafayette, LA 70501  
Phone: (337) 261-3549

(800) 274-3458

Fax: (337) 261-3771

E-mail: [don@htfdistributors.com](mailto:don@htfdistributors.com)

Web: [www.htfdistributors.com](http://www.htfdistributors.com)



# CHANCE®

Web: [www.abchance.com](http://www.abchance.com)

**UNITED STATES**  
HUBBELL POWER SYSTEMS, INC.  
210 N. Allen  
Centralia, Mo 65240  
Phone: 573-682-8414  
Fax: 573-682-8660  
e-mail:  
[hpsliterature@hps.hubbell.com](mailto:hpsliterature@hps.hubbell.com)

**CANADA**  
HUBBELL CANADA, INC.  
870 Brock Road South  
Pickering, Ontario L1W 1Z8  
Phone: 905-839-1138  
Fax: 905-831-6353  
e-mail:  
[infohps@hubbellonline.com](mailto:infohps@hubbellonline.com)

**MEXICO**  
HUBBELL DE MEXICO, S.A. DE. CV  
Av. Coyoacan No. 1051  
Col. Del Valle  
03100 Mexico, D.F.  
Phone: 52-55-9151-9999  
Fax: 52-55-9151-9988  
e-mail: [vtasdf@hubbell.com.mx](mailto:vtasdf@hubbell.com.mx)

NOTE: Because Hubbell has a policy of continuous product improvement, we reserve the right to change design and specifications without notice.